



HERMES
TOOLS

2019



**GOOD SERVICE IS ALWAYS CLOSE TO THE
CUSTOMER. FOR QUICK RESPONSES, FAST
PROCESSES AND SATISFIED CUSTOMERS.**

WELCOME TO THE DIGITAL WORLD OF LÜBBERING FASTENING TECHNOLOGY.

LÜBBERING DIGITAL is an online platform which has been specially developed to meet the needs of planners and users of LÜBBERING fastening systems and to support LÜBBERING sales partners. We want to give our customers and partners the information that they need in the shortest possible time. Unfiltered expertise directly from the manufacturer.

The new online platform contains five different modules with various functions relating to LÜBBERING fastening technology. Take a look inside and find out more about the modules in detail.

One thing is for certain: We love progress and will continue to develop LÜBBERING DIGITAL to specifically meet your needs. Register at www.luebbering.de/digital and see for yourself.

We hope that you really enjoy using the opportunities available to you in LÜBBERING DIGITAL.

YOUR ADDED VALUES

- + Significant time saving through a fast flow of information – directly from the manufacturer
- + Comprehensive modules with many different functions
- + Configure your individual fastening systems quickly and easily
- + Look for and quickly find single L.SP3 components
- + Manage your own fastening system with access to 2D product drawings, 3D data, parts lists, requirement lists for spare parts procurement and much more
- + Look at your training documents and certificates at any time and inquire directly about dates for workshops
- + Available on your mobile device

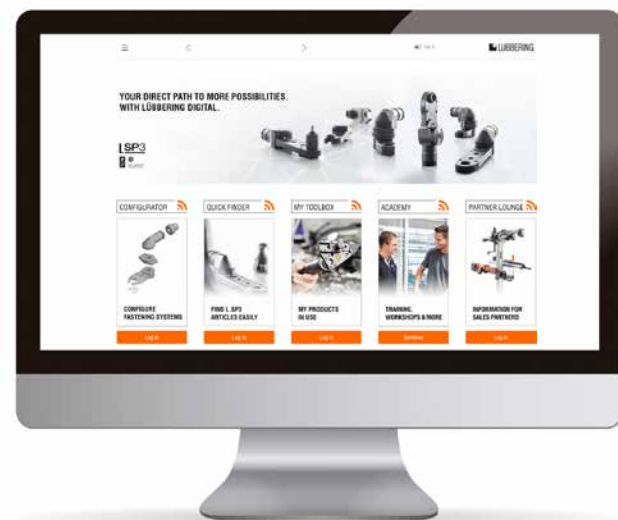

Conveniently available on all your devices at any time – on the move on your smartphone, tablet, laptop or on your desktop pc.





**YOU KNOW THE FASTENING APPLICATION.
WE KNOW THE SOLUTION. SIMPLY
PROJECT IT YOURSELF ONLINE.**



WITH ONLY A FEW CLICKS TO YOUR OWN L.SP3 FASTENING SYSTEM.

Configure your individual L.SP3 fastening system from our LÜBBERING standard programme of the third generation independently. We will guide you step by step through the configuration of your complete L.SP3 tool. Depending on your application (screw, nut or cap nut), you have the possibility of a custom-fit selection of geared offset heads, angle heads, drive machines as well as optional accessories. You can be sure that you will get exactly the fastening system you need.

While configuring your fastening system, we support you with descriptive pictures to facilitate the entry of the technical parameters. You will receive 2D drawings including the technical data of each system component, as well as 3D-CAD models.

You can submit an inquiry directly from the L.SP3 Configurator and will then receive a quotation from our sales team shortly after. Alternatively, you can save your configuration in your account, call it up at any time and send your inquiry later.

YOUR ADDED VALUES

- + Complete fastening system configurable – from a geared offset head and angle head up to drive unit
- + Easy to use: step by step to your individual fastening system
- + Access to 2D product drawings and 3D data
- + Selection of drive machines of numerous manufacturers
- + Complete configuration can be saved and called up at any time
- + Request the fastening system configuration directly and receive a quotation quickly

Step by step with a few clicks to your individual L.SP3 fastening system:

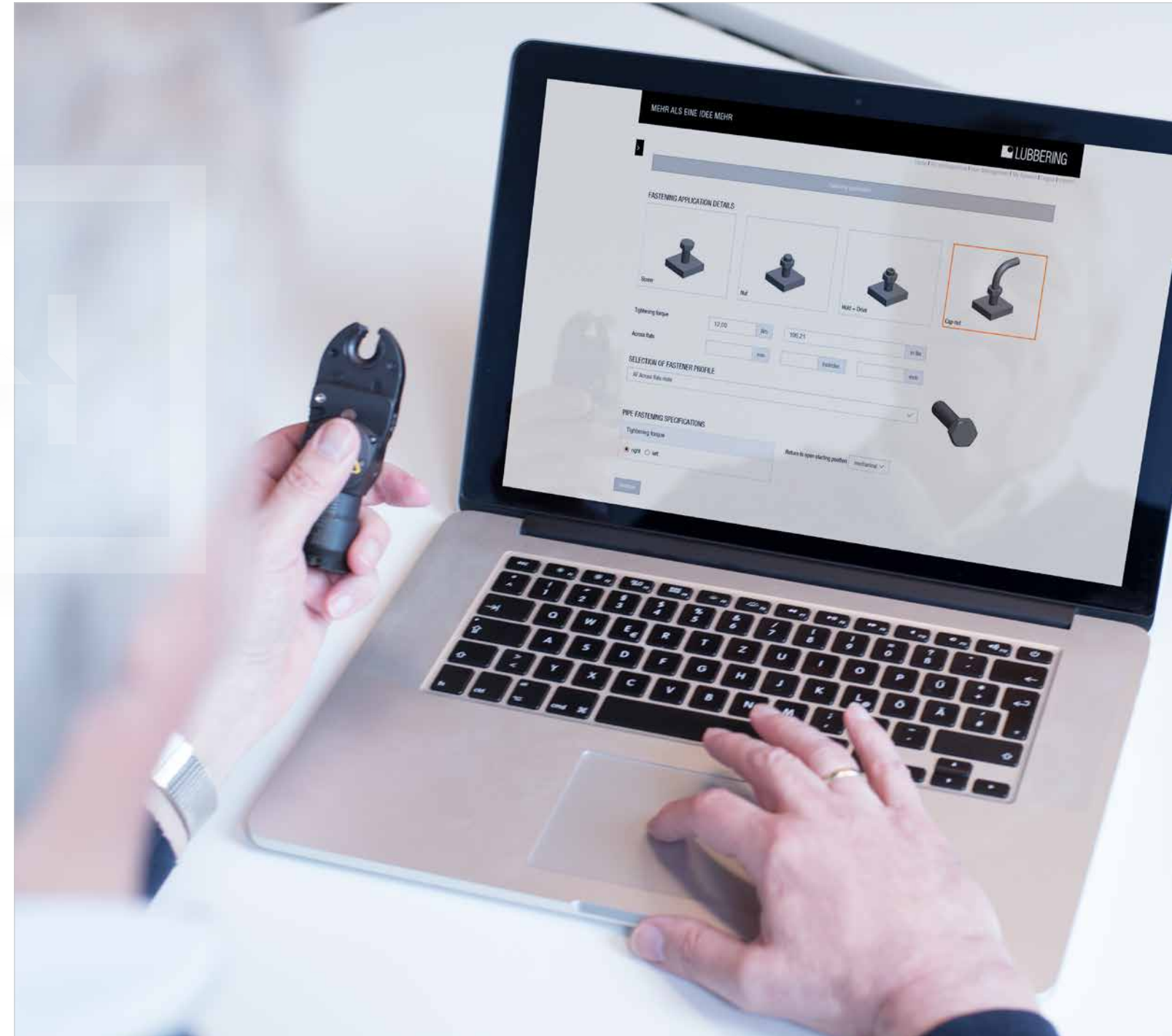
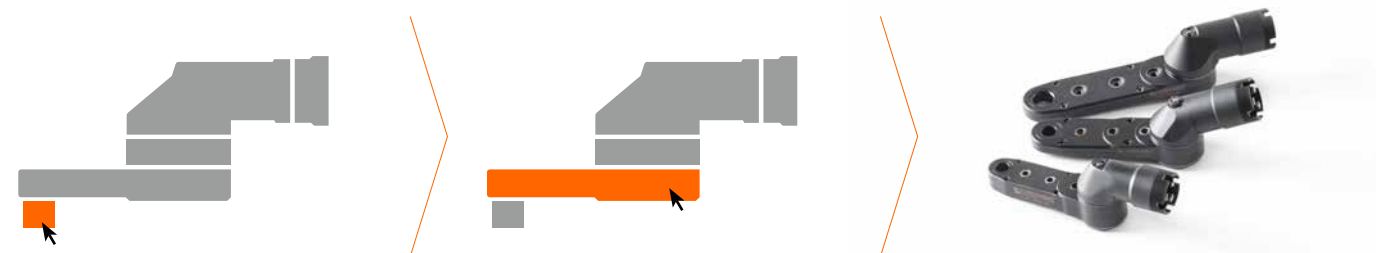



FIND EXACTLY THE PRODUCTS THAT YOU NEED. IN A MATTER OF SECONDS.

Use the quick search facility to explore the complete L.SP3 product portfolio and find out if the product with your specific parameters is available. You can search, for example, for open and closed geared offset heads – available as a standard or inline model. In addition, you will be able to search for output socket gears with various output profiles. Helpful pictures appear in order to support you with the selection of the various output variants.

In the end, you will have gained access to all the technical data of the article and the respective product drawing. In order to find the article again, you can bookmark it on the requirements list and request a quotation from LÜBBERING.

Try it and use this tool to find the latest products in our fastening system range.

YOUR ADDED VALUES

- + Quick overview of the complete L.SP3 product range
- + Quick access to all L.SP3 articles
- + Entry of technical parameters in order to check product availability
- + Technical data and product drawings
- + Bookmark fastening articles or send an inquiry
- + Look easily for single components – a complete configuration is not necessary

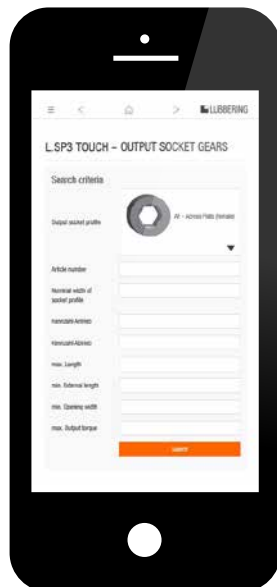

Search and find single components of an L.SP3 fastening system and add your required articles directly to your list of requirements.

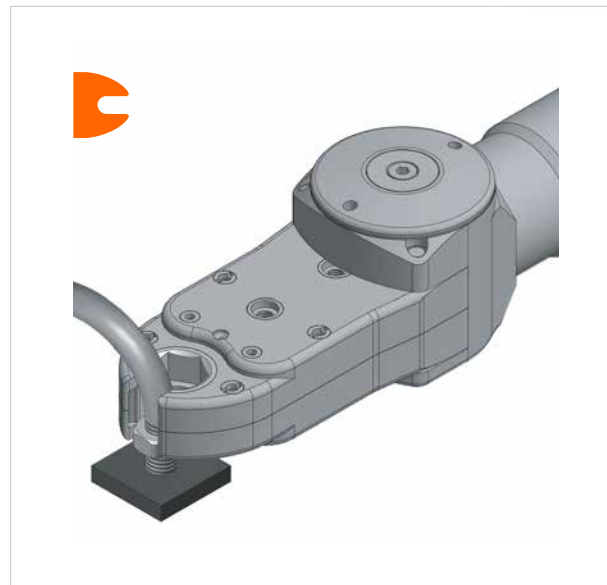

**YOU FILL YOUR TOOLBOX WITH YOUR PRODUCTS.
WE FILL IT WITH YOUR INFORMATION.**



LSP3



red dot award 2015
honourable mention



YOUR FASTENING SYSTEMS FOR DIFFERENT APPLICATIONS. ALWAYS AT A GLANCE.

The My Toolbox module is the end customer's personal toolbox – filled with LÜBBERING fastening systems.

You will always know where which products are being used and so have access to all the information and documents which relate to your fastening systems. These include, for example, operating instructions, spare parts lists or quality certificates. Expand your product data with your own photos of the product or of the operation site. To make it even more efficient, you can share your toolbox with selected teams or individual team members.

Any spare parts that you need can be easily found on the spare parts lists of your fastening systems. If you need a spare part, you can then send your inquiry directly from your My Toolbox account. You can view the processing status at any time. Our sales team will send you an offer as quickly as possible.

YOUR ADDED VALUES

- + Significant time saving through direct and quick information flow: End customer – LÜBBERING
- + Overview of your fastening systems: product information and location
- + Technical product data available anytime and everywhere
- + Form teams and share product information with each other
- + Easy to handle spare parts procurement with own requirements list
- + Preventive maintenance recommendations for your fastening systems
- + Spare parts lists | Parts lists | Quality certificates
- + Product view in 2D and 3D

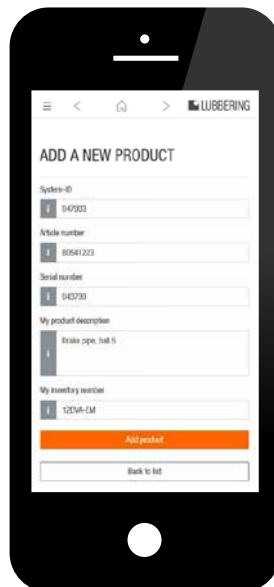

Add your product to your toolbox by entering the combination of system ID, article number and serial number.

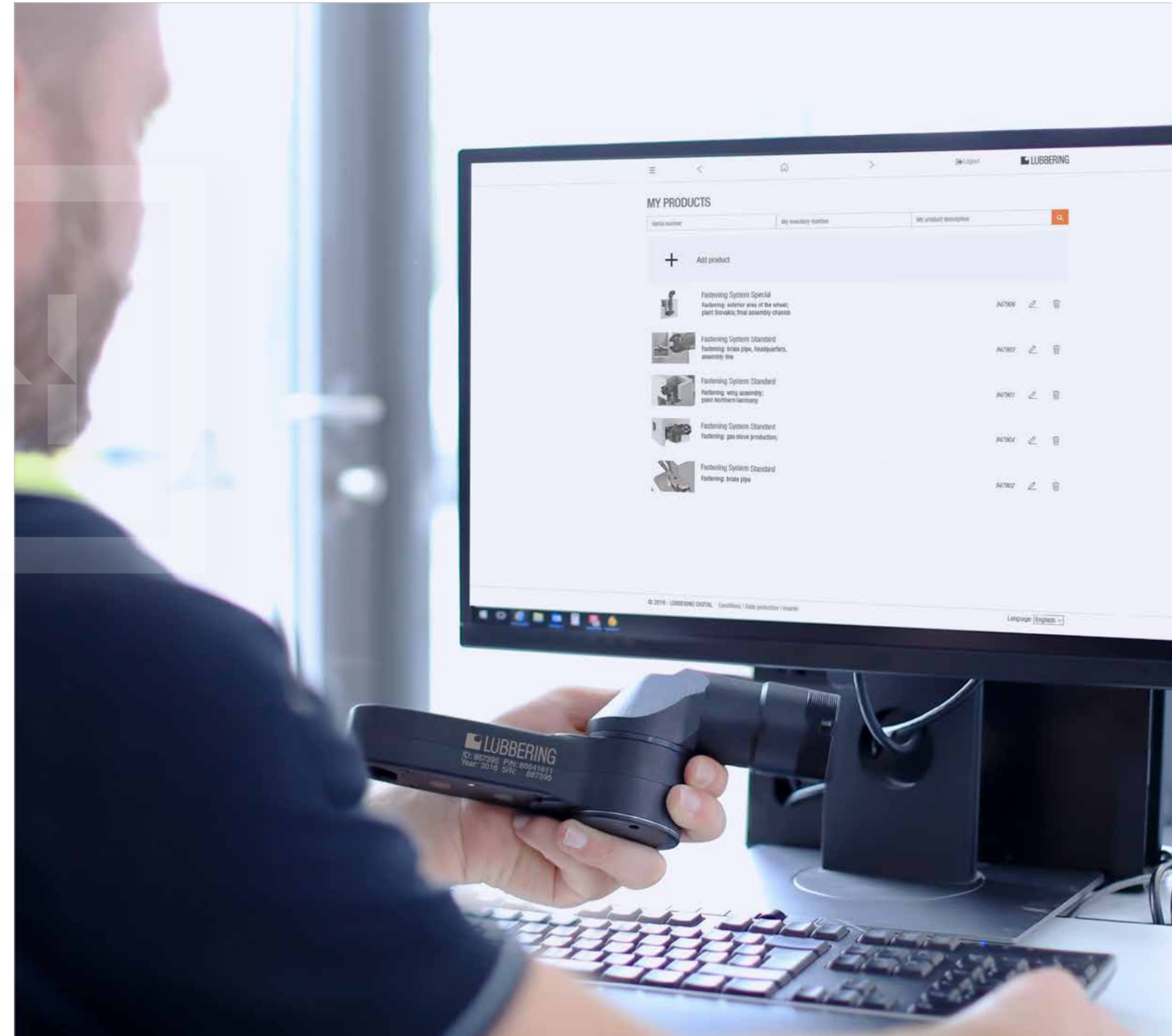

YOUR TOOLS ALWAYS IN VIEW. FOR OPTIMAL CUSTOMER SERVICE.

As a LÜBBERING sales partner, you can now view in the Partner Lounge all the product details of any LÜBBERING fastening system you have sold.

You have quick and direct access to technical product data and drawings, quality certificates and spare parts lists. You will be able to provide your customers even more quickly with information in the event of technical queries and at the same time build up a database of knowledge, which you can refer to quickly and easily when planning new projects.

YOUR ADDED VALUES

- + Significant time saving through direct access to products you have sold
- + Simple and clear order-related tool management
- + All technical product data of the products you have sold available anytime and everywhere
- + Supports fast and competent customer service
- + Spare parts lists | Parts lists | Quality certificates
- + 3D product views

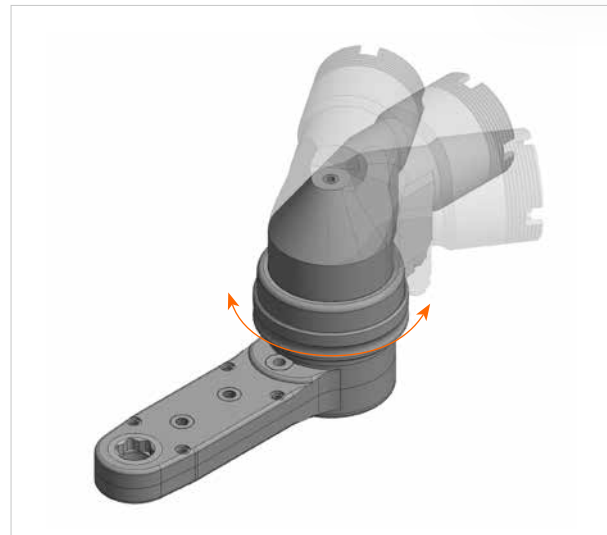
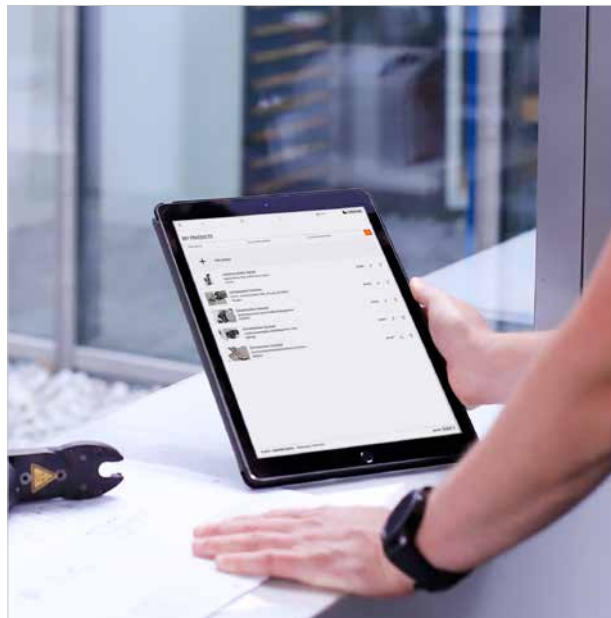
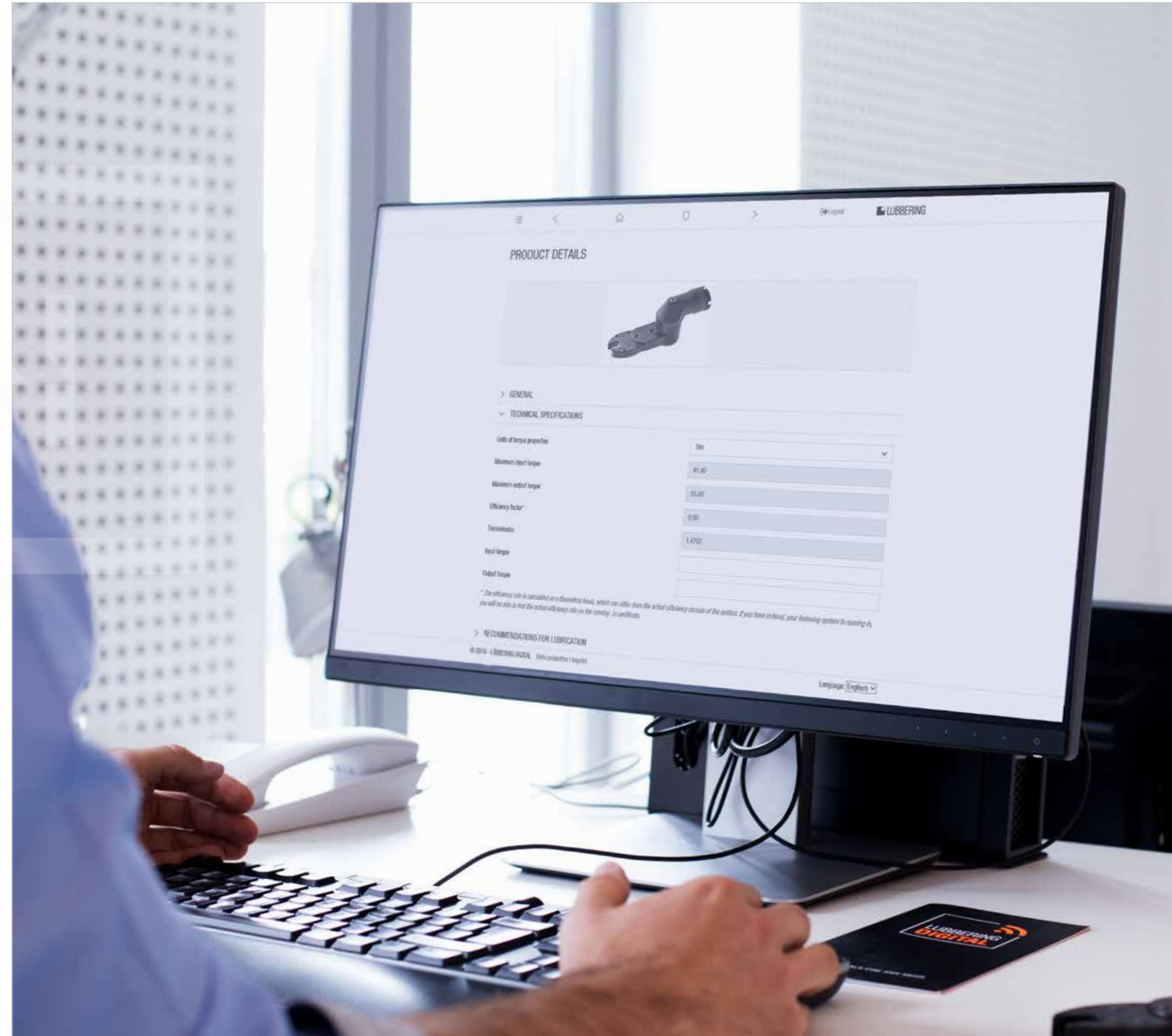

As a sales partner, you always have access to all information about your fastening systems in the Partner Lounge.



SP3 connect optionale Zwischenelemente (ZE)



- Verstellung des Winkels eines Flachtriebs um bis zu 300 Grad möglich
 - Anbringung von weiterem Zubehör möglich (z.B. Reaktionsarm)
 - Rückstellen in beide Drehrichtungen (links/rechts) nur bei offener Bauform möglich
- Standardmäßig sollte dieser bei offenen Flachtrieben immer ausgewählt werden.



ADAPTERVARIANTEN BEI L SP3 SYSTEM

- [SP3 connect] Schnellverstelladapter
- [SP3 connect] Montageflansch
- [SP3 connect] Rückstellung

i Der Rückstellung ist nur für offene Flachtriebe ein optionales Zwischenelement. Den Zwischen- und Längenkennziffern zugeordnet, die für die Auswahl des Antriebsseits wichtig sind.

MEHR ALS EINE IDEE MEHR

VISIT THE LÜBBERING ACADEMY. OUR EXPERTS SHOW YOU HOW TO BECOME AN EXPERT YOURSELF.



TAKE HOLD OF YOUR PROGRESS AND SEE THE POSSIBILITIES.

The LÜBBERING DIGITAL online platform offers an Academy module. Here, you will find all the information about the LÜBBERING training we offer. If you are interested in one of our numerous workshops, please contact us directly via the Academy module to request a training date. Our service team will prepare an individual offer for you.

The Academy module also allows you to view the training courses that you have attended at the LÜBBERING Academy at any time. You can access your personal certificates and training content such as operation instructions and videos. We will also recommend a refresher workshop whenever it is advisable.

YOUR ADDED VALUES

- + Overview of the training courses offered by the LÜBBERING Academy
- + Request training or workshops dates directly and receive a quotation quickly
- + Personal access to extensive training material and videos
- + Management of your own training certificates
- + Recommendation for a refresher workshop
- + Expert knowledge directly from the manufacturer



After participating in a workshop, you will be able to access our self-explanatory L.SP3 videos and download your certificates.





REGISTER NOW
luebbering.de/digital

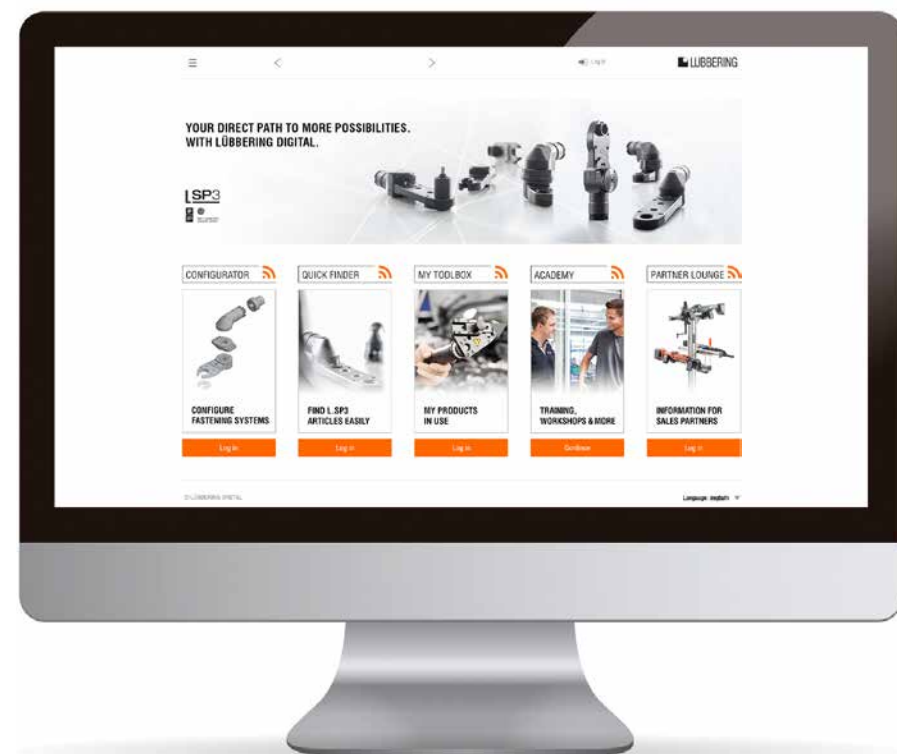

www.luebbering.de/digital



HERMESTOOLS Sp. z o.o.

ul. Sarni Stok 73 a, 43-300 Bielsko-Biała, Polska; tel: +48 33 821 41 90-91
www.hermestools.eu



Johannes Lübbering GmbH
Industriestraße 4
33442 Herzebrock-Clarholz
GERMANY

Fon: +49 (52 45) 83 09-0
Fax: +49 (52 45) 83 09-250
info@luebbering.de
www.luebbering.de



© LÜBBERING | v19_001

MEHR ALS EINE IDEE MEHR